

FRENCH FITNESS

FF-MSAT

FRENCH FITNESS MULTI-STORAGE
ACCESSORY TOWER (NEW)

ASSEMBLY MANUAL



FEATURES

- 12 Gauge Steel
- Tube Size: 2.4" x 1.5" x 2mm (60 x 40 x 2mm)
- Functional storage solution for all kinds of exercise equipment and accessories
- Space-saving design to fit into any corner
- Multiple pegs for hanging mats, bands, cable attachments and other accessories
- 3 shelves for medicine balls, slam balls, and wall balls
- 2 trays for kettlebells and dumbbells
- Has 4 caster wheels for easy mobility and transport
- All 4 caster wheels has locks to keep the storage rack in place
- Can store different sizes of exercise equipment
- Fully-customizable to better suit your storage needs

TECH SPECS

- Max Storage Capacity: 660 lbs (300 kg)
- Dimensions: 83.5"L x 31.9"W x 86.6"H (212 cm x 81 cm x 220 cm)
- Product Weight: 143.3 lbs (65 kg)

WARRANTY

- **10 Years Parts, 1 Year Labor (Commercial)**
- **California Residents see Prop 65 WARNING**

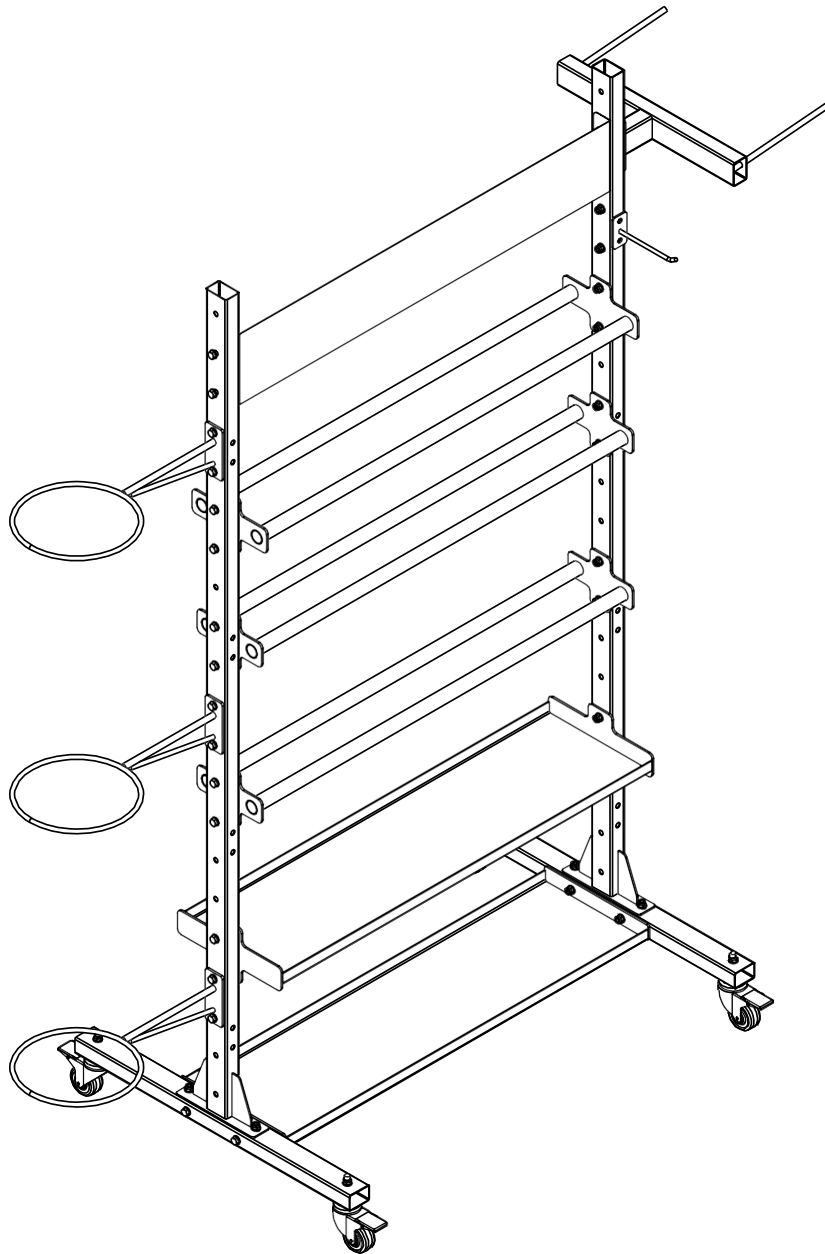

A

2pcs

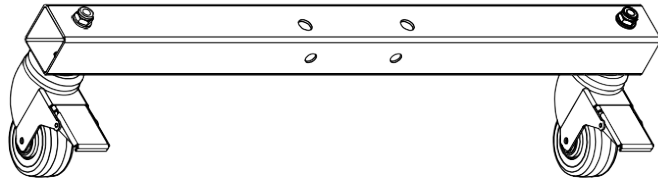
**B**

2pcs

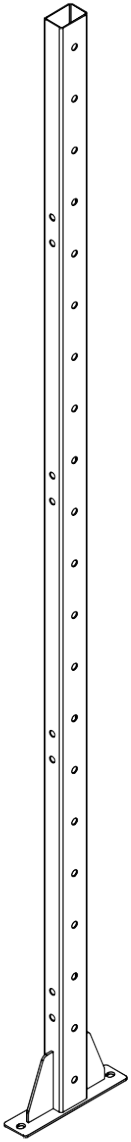
**C**

1pc

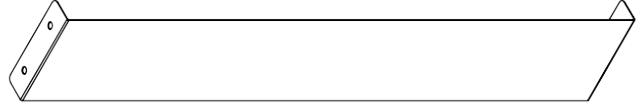
**D**

1pc

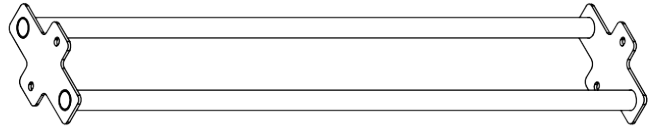
**E**

2pc

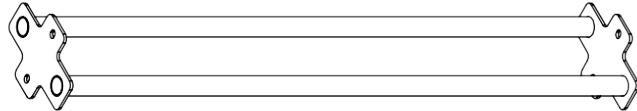
**F**

1pc

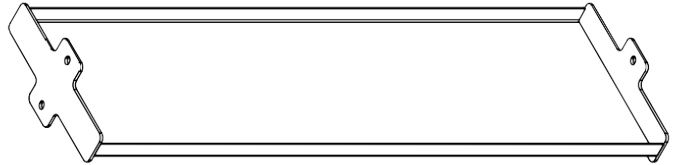
**G**

1pc

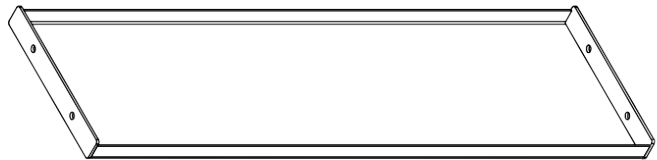
**H**

1pc

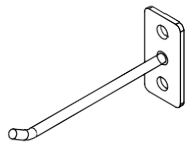
**I**

3pcs

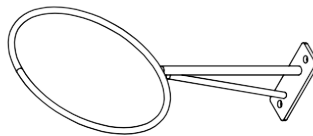
**J**

1pc

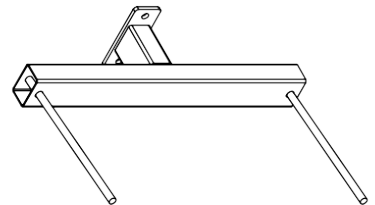
**a**

26pcs 10*60

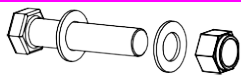
**b**

4pcs 10*70

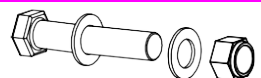
**c**

4pcs 10*80

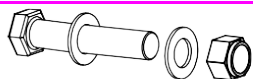

1

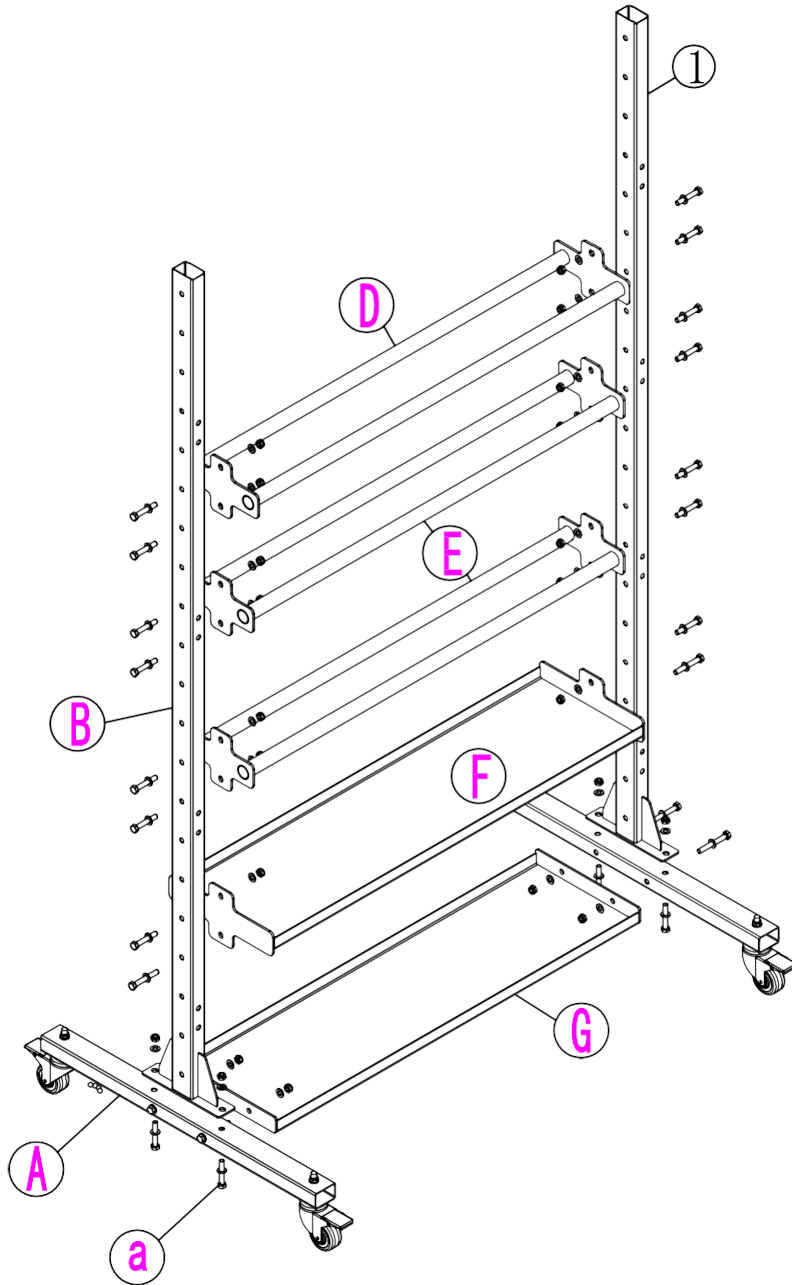

2

